

*Since 1968*

**COMMAX**  
SmartHome & Security

# CDV-77M User Manual

FINE VIEW MONITOR

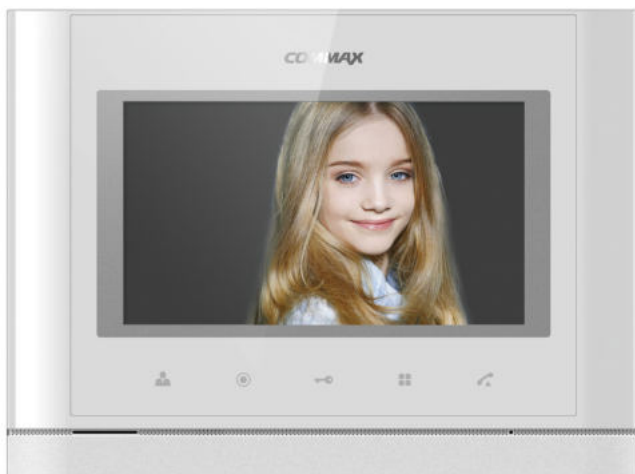

[www.commax.com](http://www.commax.com)

**COMMAX Co.,Ltd.**



- Thank you for purchasing COMMAX products.
- Please carefully read this User's Guide (in particular, precautions for safety) before using a product and follow instructions to use a product exactly.
- The company is not responsible for any safety accidents caused by abnormal operation of the product.



# Table of Contents

1. Warnings and Cautions .....	2
2. Part Names and Functions .....	3
3. Package Contents .....	3
4. Wiring and Connection Instructions .....	4
5. Installation .....	4
6. Operation .....	5
7. Settings .....	6
8. Initialization .....	7
9. Specification .....	7









## 1. Warnings and caution















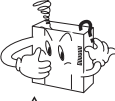





Please follow the things described below in order to prevent any danger or property damage.

 **Warning** It may cause a serious damage or injury if violated.

 **Caution** It may cause a minor damage or injury if violated.

-  Prohibition.
-  No disassembly
-  No touch
-  Must follow strictly.
-  Shows plugging out the power cord without an exception
-  Shows the warning and caution for an electric shock.
-  Shows the warning and caution for a fire.

### Warning & Caution

<b>Cleaning &amp; Use</b>	<p>Please don't disassemble, repair or rebuild this product arbitrarily (please contact the service center if a repair is needed).</p> <ul style="list-style-type: none"> <li>It may cause an electric shock or fire.</li> </ul>  	<p>If an abnormal sound, burning smell or smoke is coming out of the product, please plug out the power cable and contact a service center.</p> <ul style="list-style-type: none"> <li>It may cause an electric shock or fire.</li> </ul>   	<p>Please don't insert any metallic or burnable materials into the ventilation hole.</p> <ul style="list-style-type: none"> <li>It may cause an electric shock or fire.</li> </ul>    	<p>When cleaning the product, please rub it with a soft and dry cloth after plugging out the power cable. (Please don't use any chemical products such as wax, benzene, alcohol or cleanser.)</p>  
	<p> Electric shock</p> <p> Fire</p> <p> Unplug</p>	<p> Electric shock</p> <p> Fire</p>	<p> Prohibition</p> <p> Electric shock</p> <p> Fire</p>	<p> Prohibition</p>

## ⚠ Warning & Caution

### Power & Installation

Please don't use several products at the same time on one power socket.

- It may cause a fire due to an abnormal overheating.

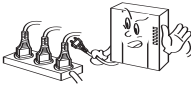

Please don't bend the power cable excessively or it may cause an electric shock.

- fire when using a damaged power cable.

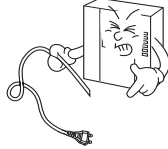

Please don't handle the power cable with a wet hand.

- It may cause an electric shock.

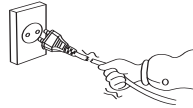

Please plug out the power cable from the socket when not using it for a long period of time.

- It may shorten the product lifespan or cause a fire.



Please don't install the product in the place where there is much oil, smoke or humidity.

- It may cause an electric shock or fire.

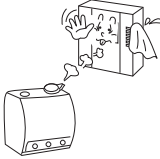

Please don't install the product with the lightning and thunder.

- It may cause an electric shock or fire.

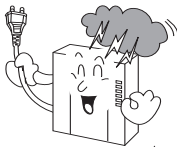

Please don't use and connect this product with other products with different rated voltage.

- It may cause a disorder or fire.

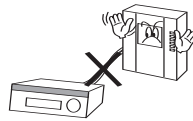

When installing the product that generates heat, please install the product away from the wall (10cm) for the ventilation.

- It may cause a fire due to the increased internal temperature.

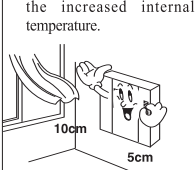

## 2. Parts Names

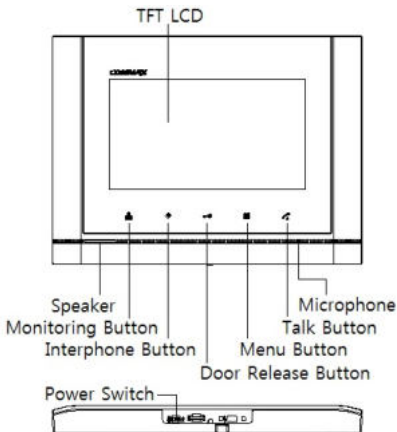

## 3. Contents

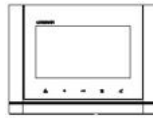

Video Phone (CDV-77M)

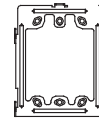

Wall bracket for monitor (1EA)



User Manual (1EA)

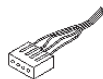

Camera connector (CONN. 4P\*200) (2EA)



Monitor fixing Screw PHM 3\*6 ZnY

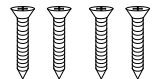

Screw for wall bracket (Screw GH1T 4\*18 ZnW)



## 4. Wiring and Connection Instructions

### ▷ Polarity of the camera connector

1. Red: Talk (Audio)
2. Blue: GND
3. Yellow: Power (+12V)
4. White: Video

### ▷ Polarity of interphone connector

1. Red: Talk (Audio)
2. Blue: GND
3. Yellow: Power (+14V)
4. White: Call signal

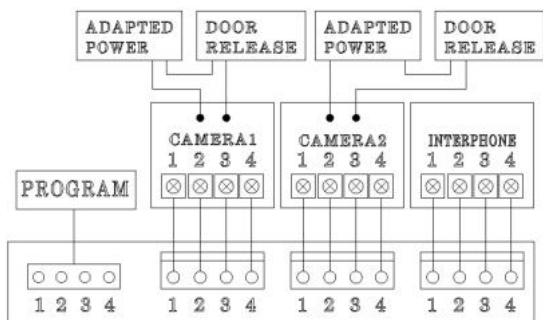

\* Each device should be connected by separated cables.  
If you use UTP CABLE[CAT.5] for CAMERA1 and CAMERA2, 2 lines of UTP cable are required.

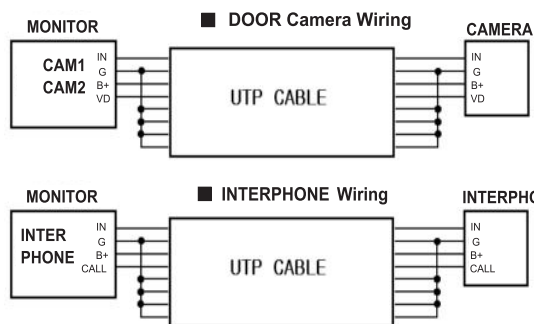

## 5. Installation

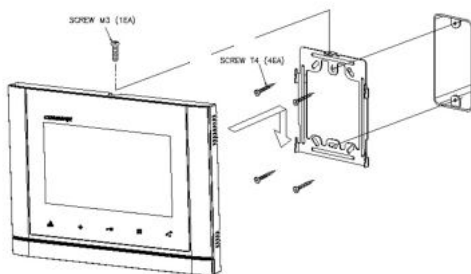

### ⚠ Cautions

- ① Avoid the direct sunlight.
- ② Recommended height is around 1450~1500mm
- ③ Avoid the installation near magnetic activity, humid temperature and gas.



# 6. Operation

## 1. Calling of visitor

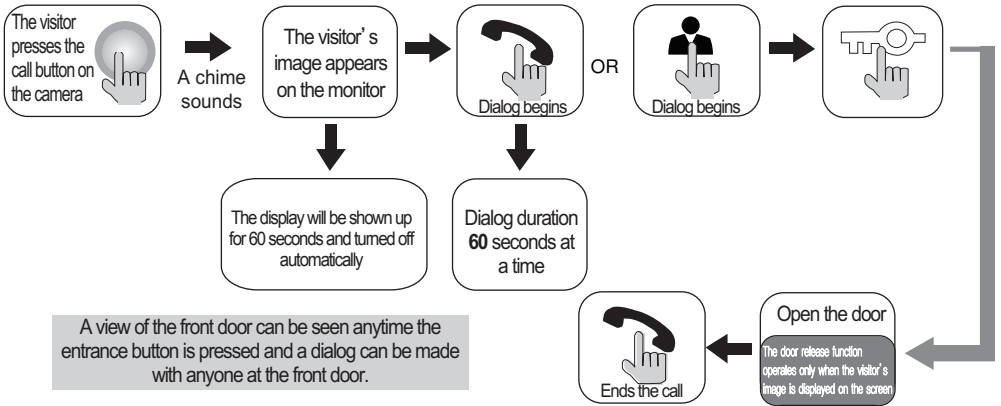

### \* In case of connecting two cameras

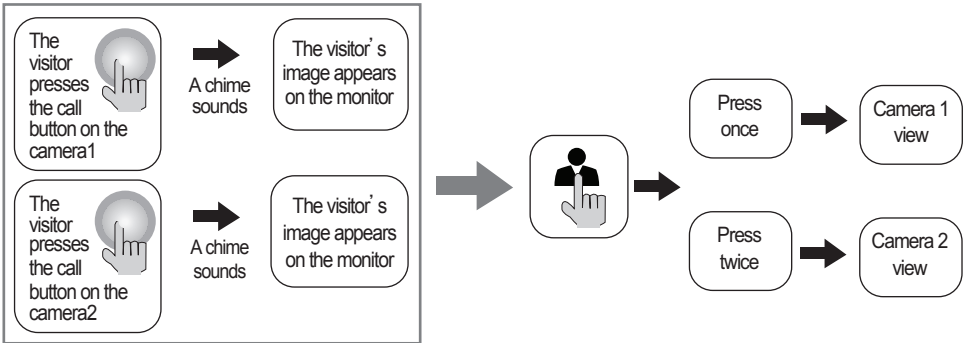

## 2. Communication with the optional Interphone

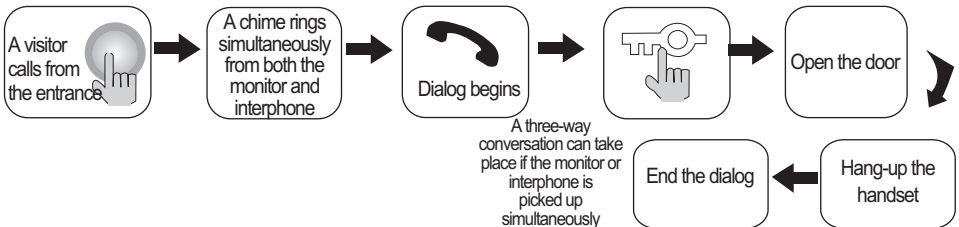

Dialog between the interphone and camera is possible only when the visitor's image is visible on the monitor screen.



## 7. Settings

After Menu screen appears, you can change setting with below 4 buttons

Menu start and finish : [  ] (Menu button -'[  ]')

SELECT : [  ] (Interphone button-'[  ]')

Move upward /move right : [  ] (Door release button -'▲' / '▶')

Move downward /move left : [  ] ( Monitoring button-'▼' / '◀')

After pressing MENU button in Video call or monitoring mode, you can change settings for DOOR VIDEO SET(BRIGHTNESS / CONTRAST/ COLOR), UTILITY (ADDITIONAL FUNCTION) and INFORMATION (product information)

### 4-1. Screen setting (Brightness/Contrast/Color adjustment function)

Press the MENU button and access to DOOR VIDEO SET and enter the setting menu by pressing the SELECT button.

- (1) BRIGHTNESS: Adjusting Brightness of Screen.
- (2) CONTRAST: Adjusting Contrast of Screen.
- (3) COLOR: Adjusting Color of Screen.

You can control from 0 to 20 level. Initial level is set for level 10

※ how to set

After moving to menu with your desired MENU from 'DOOR VIDEO SET', press SELECT button to move to the menu below

- (4) RESET: reset display setting

※ how to set

After moving to RESET from DOOR VIDEO SET, press SELECT button for RESET.

Select YES with move button.

Complete your setting by pressing SELECT button

- (5) EXIT : Go back to setting mode

### 4-2. UTILITY(additional function)

Press the MENU button and access to UTILITY and enter the menu by pressing the SELECT button.

- (1) SPEAKER-VOLUME: setting receiver sound level .

There are 3 levels of volume control options and default is level 2

※ how to set

After moving to SPEAKER VOLUME from UTILITY, press SELECT button for SPEAKER VOLUME.

Select your desired setting.

Complete your setting by pressing SELECT button

- (2) CHIME-BELL VOLUME : setting call sound level.

You can control from 0(MUTE) to 3 level. Initial level is set for level 2.

※ how to set

After moving to CHIME-BELL VOLUME from UTILITY, press SELECT button for CHIME-BELL VOLUME.

Select your desired setting.

Complete your setting by pressing SELECT button.

(3) SCREEN MODE : to set for screen ratio.

**\* How to adjust**

※ how to set

After moving to SCREEN MODE from UTILITY, press SELECT button for SCREEN MODE.

With ▲/▼ button, select your desired setting.

Complete your setting by pressing SELECT button.

◆ ZOOM :4:3 display is changed into full display mode (default)

◆ 4:3 : actual ratio of camera.

◆ WIDE : display is changed into 16:9 display mode

(4) EXIT: Go back to the UTILITY Setting menu.

4-3. INFORMATION (The function to check Model name & Version)

In order to check the product information, Press the menu button and move to INFORMATION menu with UP/DOWN button.

(1) MODEL : You can check the model name.

(2) VERSION : You can check the model version.

(3) SYSTEM : SINGLE (FINE VIEW VIDEOPHONE)

(4) TOUCH : You can check the touch-key version.

(5) VIDEO : You can check the video transmission formats(NTSC/PAL)

(6) SOURCE : You can check the position of camera(DOOR1 / DOOR2) which is shown on the screen for now.

4-4. EXIT (Finish setting menu)



## 8. Initialization (RESET)

- Press the interphone button and door release button at the same time for about 3 seconds. Then, image setting value and sound volume will be initialized.



## 9. Specification

SPEC	CDV-77M		
Wiring	Door camera 4wires (Polarity), interphone 4wires (polarity)		
Rating Voltage	CDV-77M : 100-240V~, 50/60Hz(FREE VOLTAGE)		
Power consumption	Stand-by : 3 W	Maximum: 15 W	
Transmission way	HANDS FREE (Voice switch circuit)		
Screen size	7" TFT-DIGITAL LCD		
Ringtone	Door : Electronic chime (Sol Mi Do), Interphone : Beep		
Display	Monitoring : 30 ±5sec		Talk : 60 ±5sec
Distance(Cable thickness)	Pie 0.5mm	0.65mm	0.8mm
	28m	50m	70m
Working temperature	0 ~ +40°C (32°F ~ 104°F)		

# **COMMAX**

**COMMAX Co.,Ltd.**

513-11, Sangdaewon-dong, Jungwon-gu, Seongnam-si, Gyeonggi-do, Korea

Int'l Business Dept. Tel. : +82-31-7393-540~550 Fax. : +82-31-745-2133

Web site : [www.commax.com](http://www.commax.com)

*Printed In Korea / 2020.08.104*

*Edited.2020.08.10*